

OCELOVÉ KONSTRUKCE JAKO SOUČÁST ARCHITEKTURY



CEITEC - Středoevropský technologický institut



CEITEC - Středoevropský technologický institut



CEITEC - Středoevropský technologický institut



CEITEC - Středoevropský technologický institut



CEITEC - Středoevropský technologický institut



CEITEC - Středoevropský technologický institut





CEITEC - Středoevropský technologický institut



CEITEC - Středoevropský technologický institut



Pavilon P - Veletrhy, Brno

STYČNÍK



Pavilon P - Veletrhy, Brno

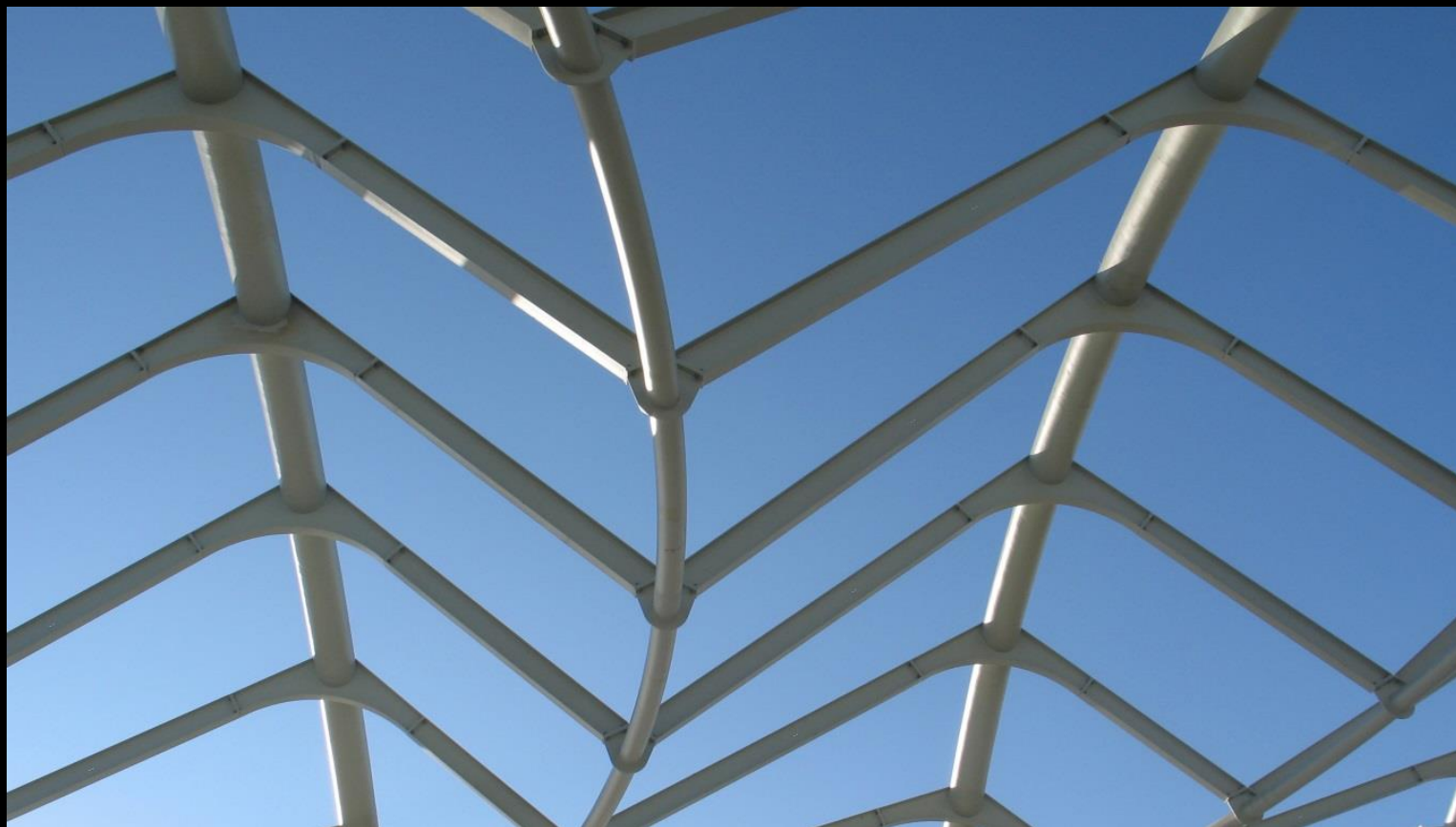

Terminál odlet - Letiště, Brno

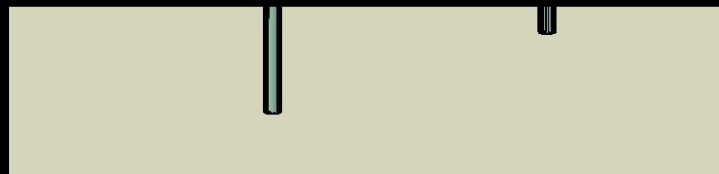
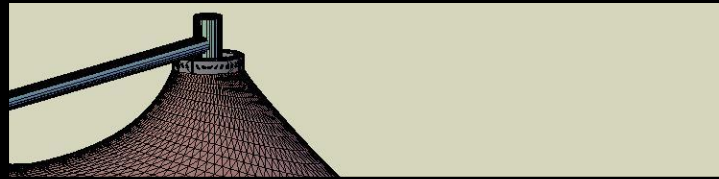

Pizzeria La Patas, Brno

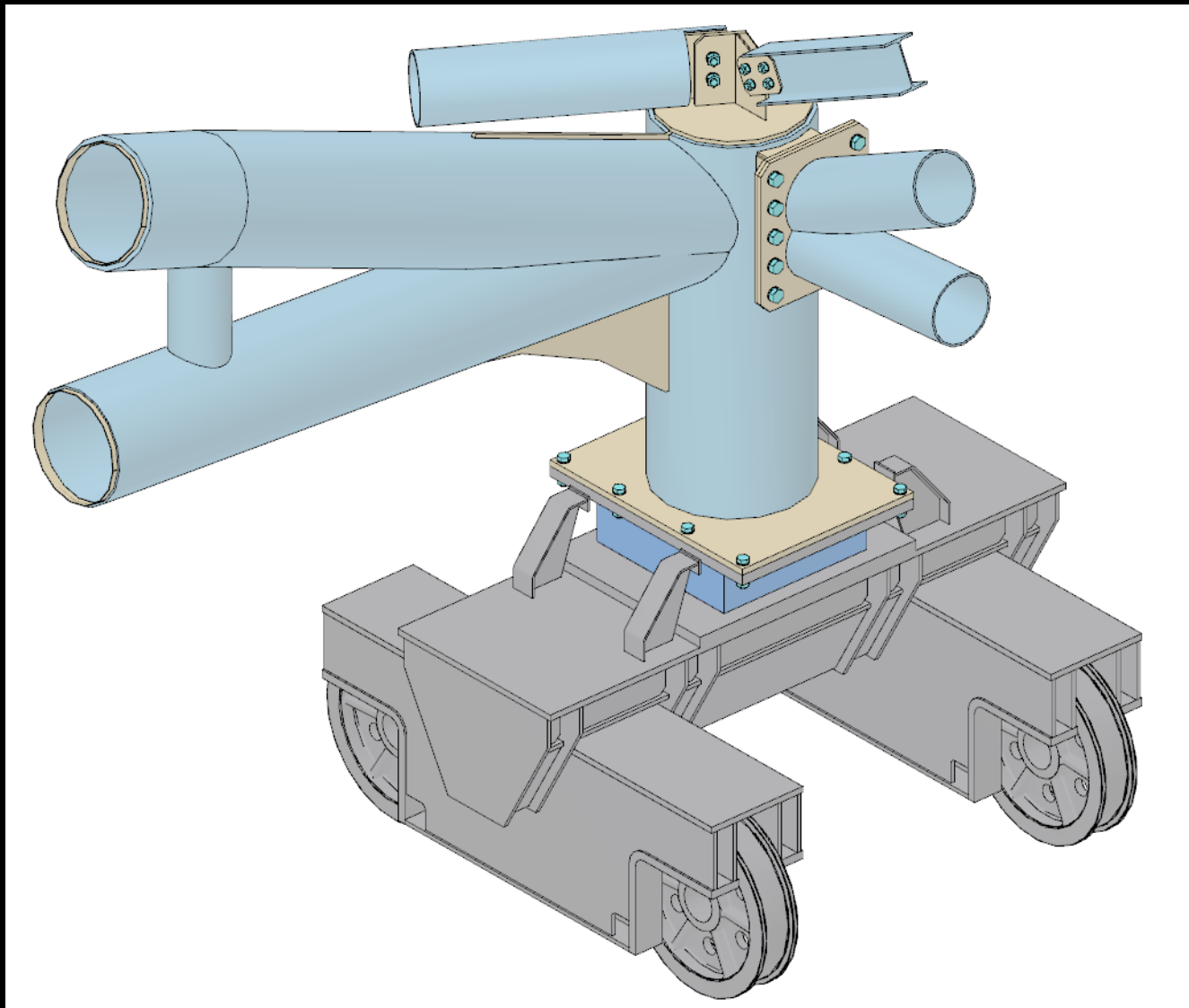

Stadion Zenit, Petrohrad

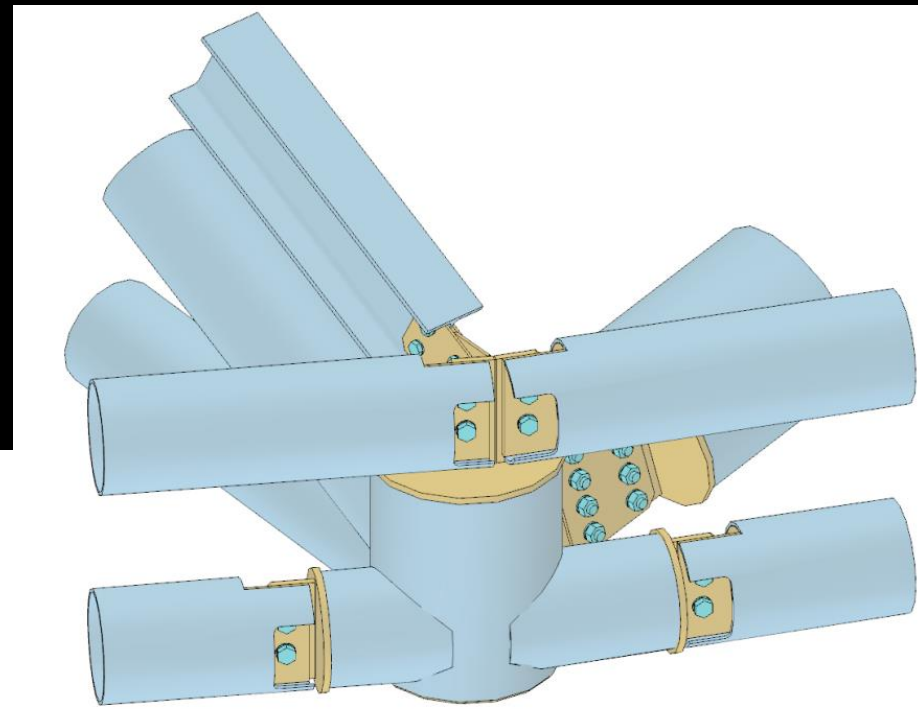
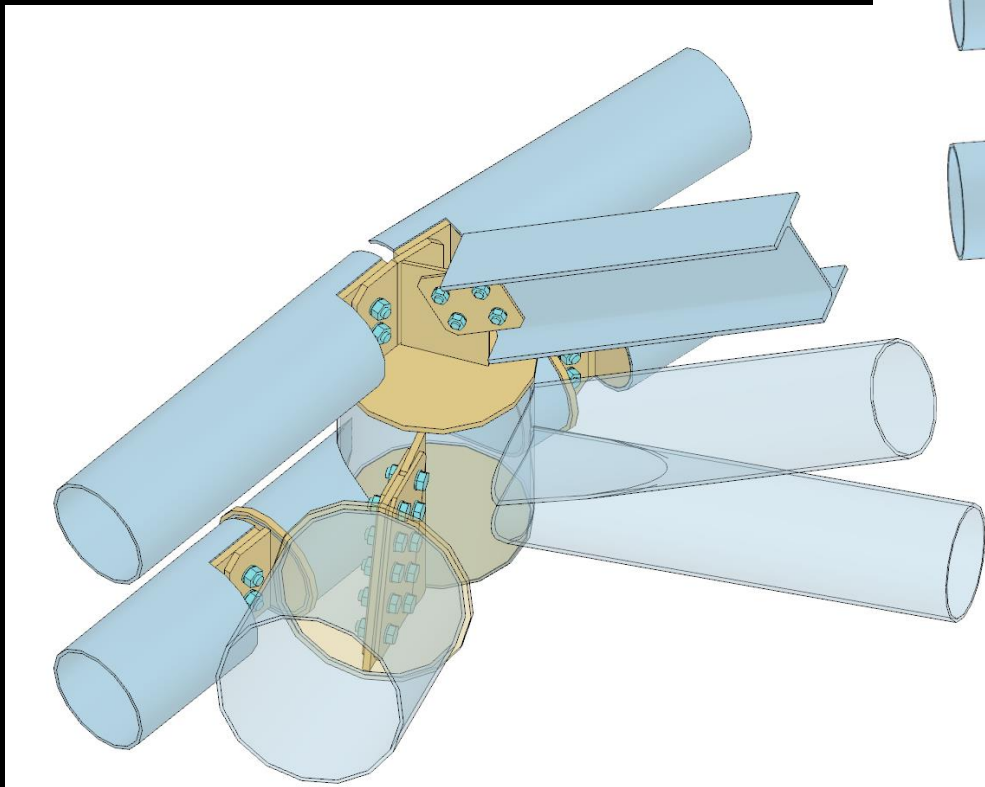

Stadion Zenit, Petrohrad

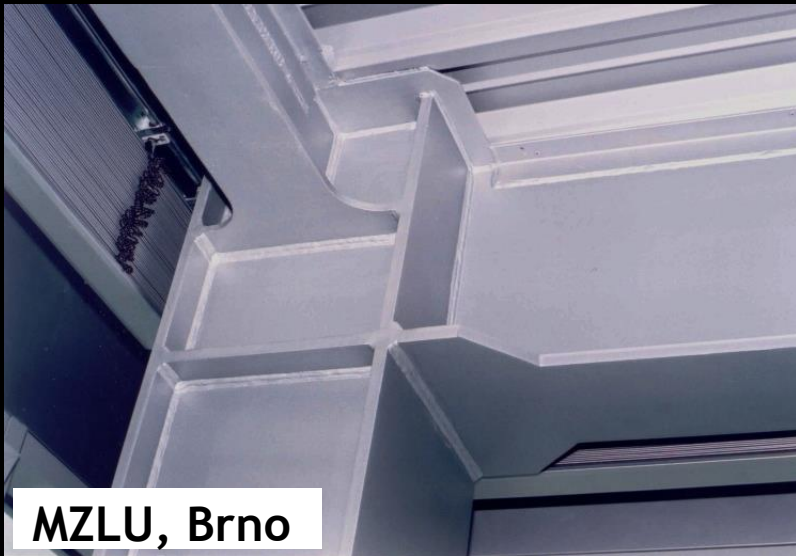

MZLU, Brno



MZA, Brno



JMP - RWE, Brno

HLAVICE SLOUPŮ



Starý most - montáž, Bratislava



Pavilon P, Veletrhy, Brno

KLOUB

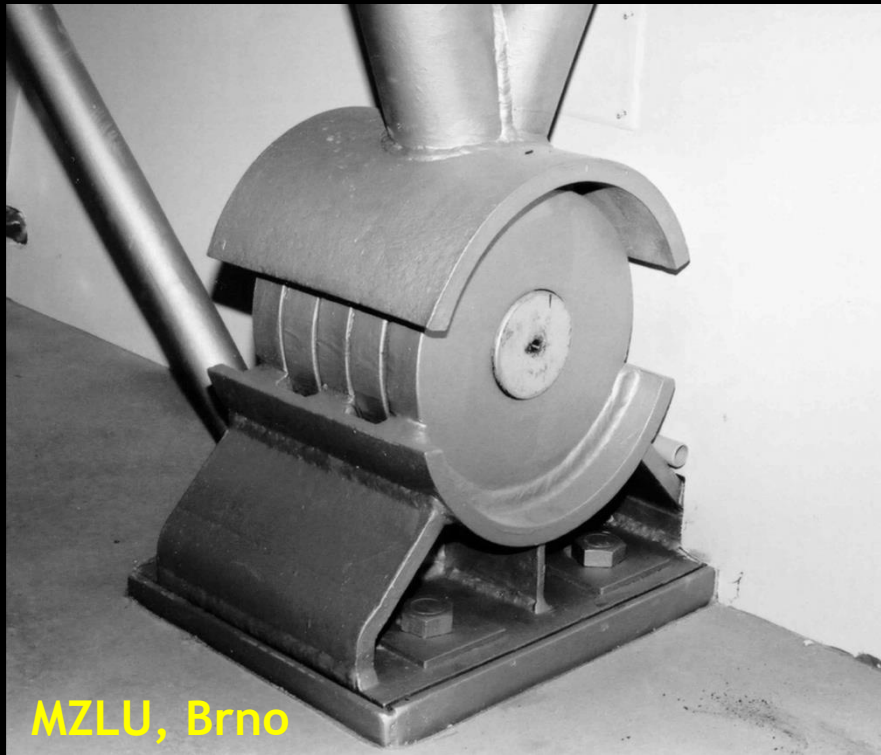

MZLU, Brno

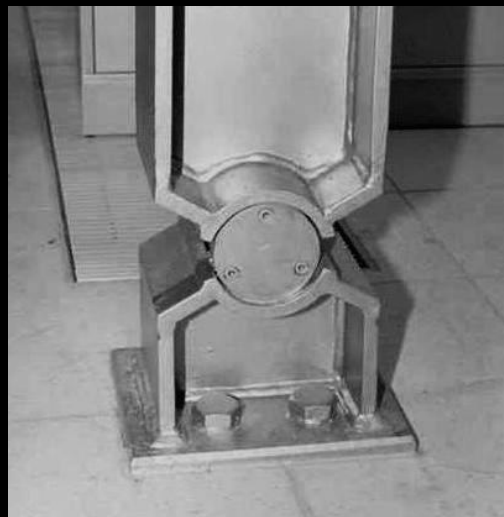

JMP - RWE, Brno



Kampus MU, Brno



D47, most SO 9202 - Odra III

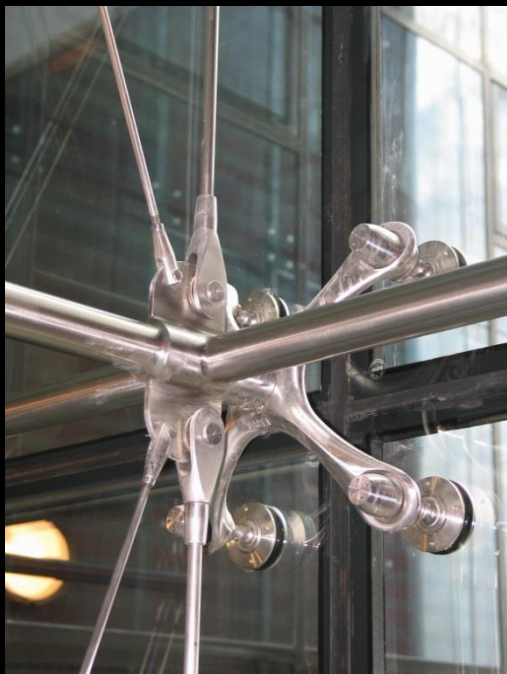

Speciální multi-klouby

OKF



MZA, Brno

STRUKTURA

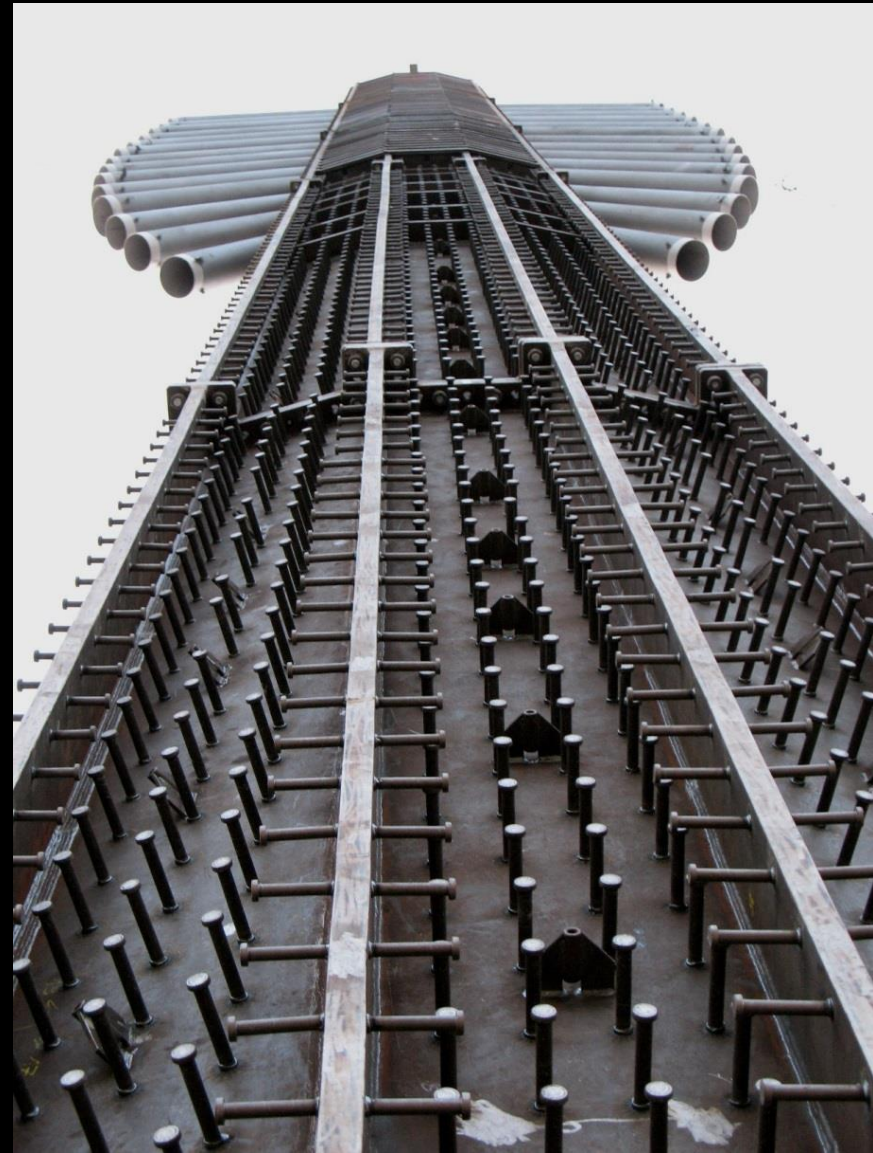
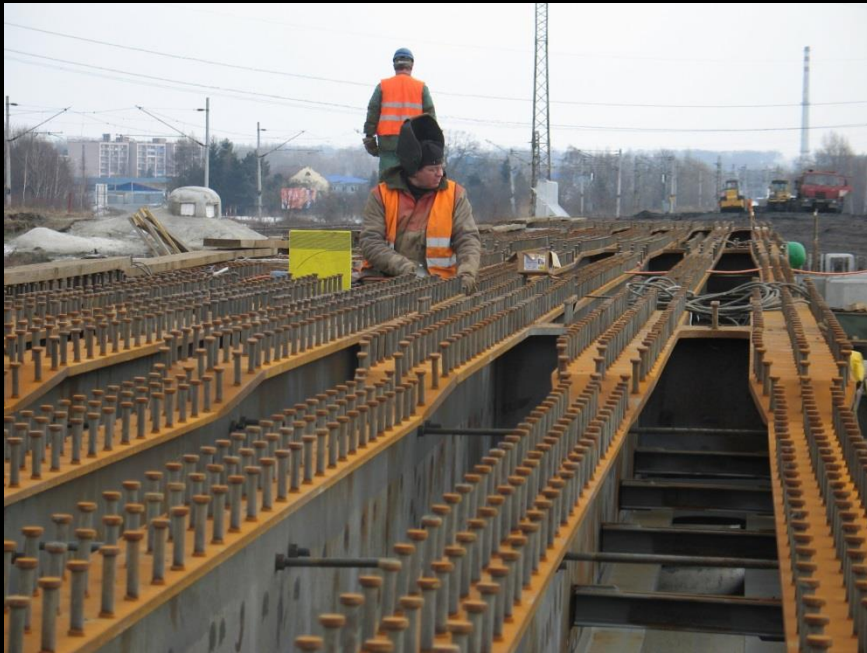

D47 mosty



Starý most - montáž, Bratislava



Kampus MU, Brno

SCHODY



Pavilon P, Veletrhy, Brno

- Lávky
- Markýzy
- Fasády
- Interier
- Sklobeton
- ...





- Lávka
- Mark
- Fasád







Architektura, spolupráce a fotodokumentace:
APLUS, ArchDesign, Atelier Chlup, FAPAROLLI, SHP a další



CEITEC

STŘEDOEVROPSKÝ TECHNOLOGICKÝ INSTITUT

Kampus Masarykovy univerzity, Brno

Architektura a fotodokumentace:
APLUS, Brno



OKF

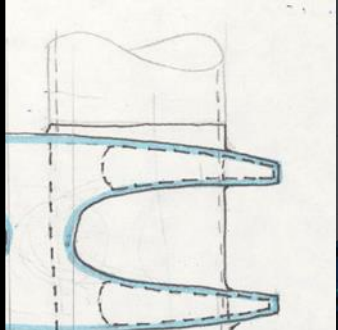
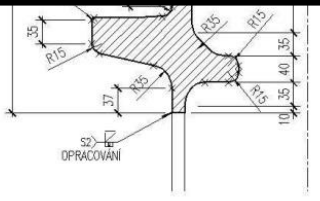
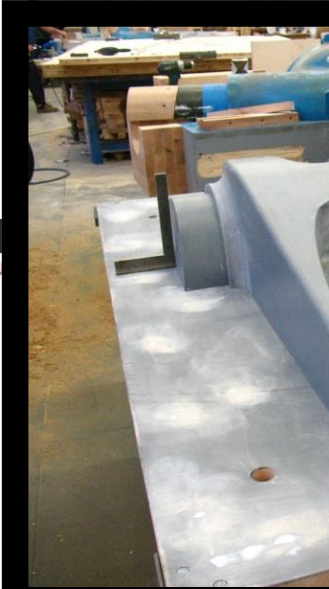
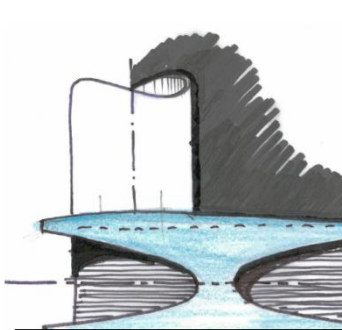

OKF





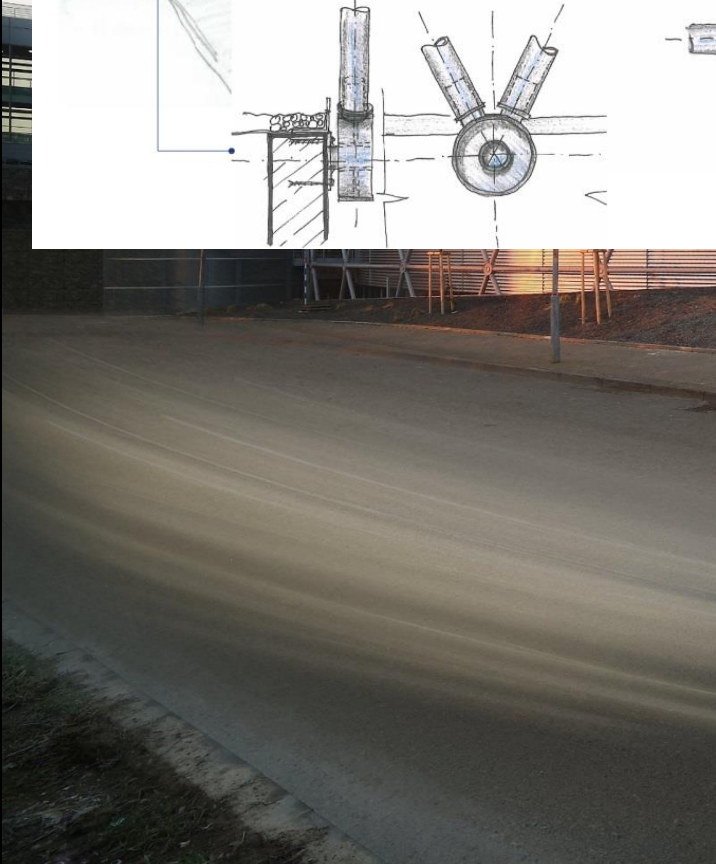
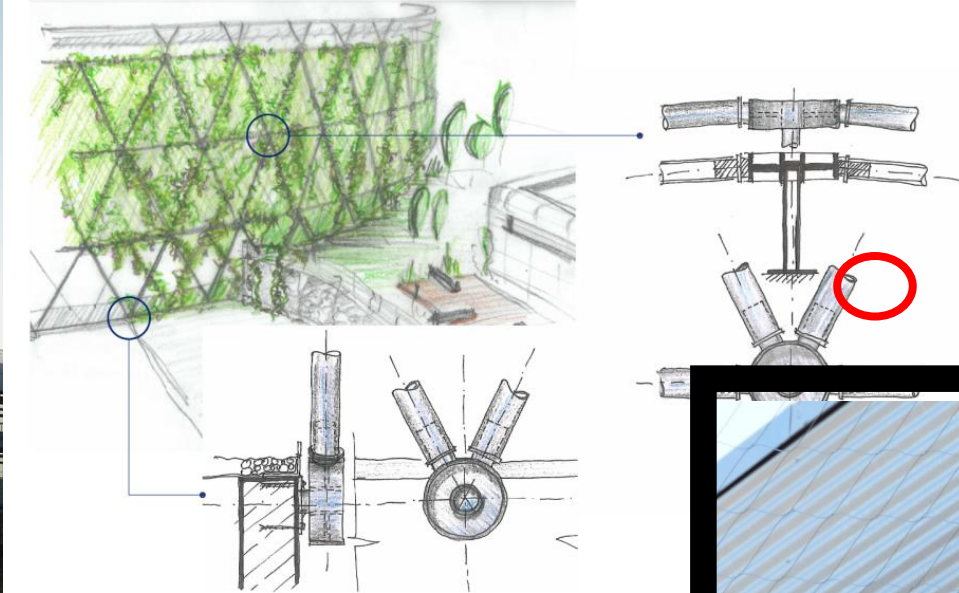







OKF s.r.o.
Čechyňská 18
Brno